

# Combined Electrodes

## Table of Contents

1 Standard Products.....	1
1.1 Platinum.....	1
1.1.1 805/CPG/12.....	1
1.1.2 805/CPG/12R.....	1
1.1.3 805/CPG/6.....	2
1.1.4 805/CPG/5.....	2
1.1.5 805/CPG/5G.....	2
1.2 Silver.....	3
1.2.1 800/CSG/12.....	3
2 Custom Products.....	3
2.1 Conical Tapered Joint.....	3

## 1 Standard Products

The products listed below are commonly available in our warehouse, but we are glad to deliver any ad hoc solution for you needs. Please refer to section 2 for customization capabilities and feel free to submit your request to our team. Dimensions in mm.

### 1.1 Platinum

#### 1.1.1 805/CPG/12

Standard combined electrode, platinum ball tip and Ag/AgCl reference with lateral ceramic frit. Compatible with 391/CR plastic NS12 conical tapered joint adapter.

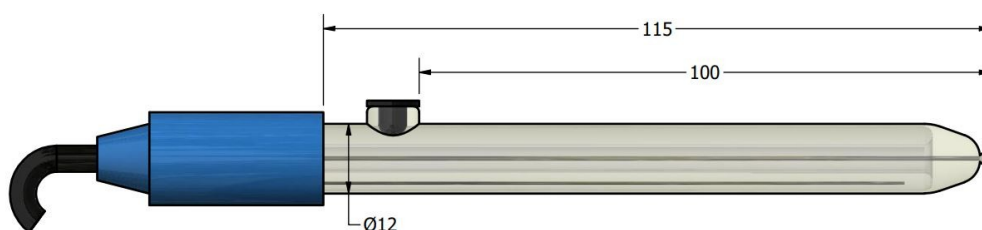

#### 1.1.2 805/CPG/12R

Combined electrode, platinum ring and Ag/AgCl reference. Compatible with 391/CR plastic NS12 conical tapered joint adapter. S7 connector.

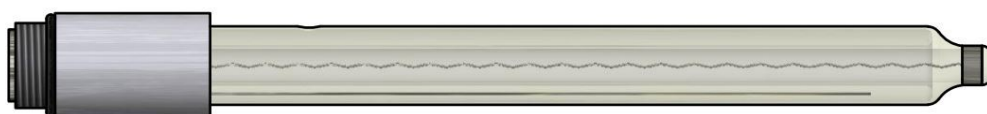

### 1.1.3 805/CPG/6

Standard combined electrode, platinum ball tip and Ag/AgCl reference with lateral ceramic frit. Glass body and lateral filling plug for 3.3M KCl solution. Compatible with 391/CR6JZ PTFE NS6 conical tapered joint adapter.

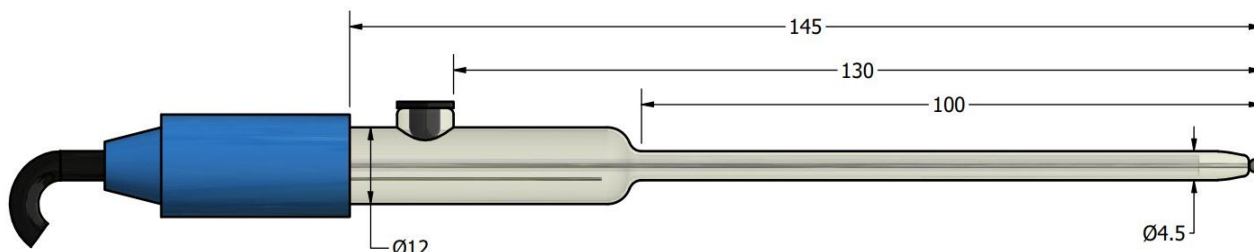

### 1.1.4 805/CPG/5

Combined electrode, platinum ball tip and Ag/AgCl reference with frontal ceramic frit. Glass body and lateral filling plug for 3.3M KCl solution. Developed for EC Minicell, for upright applications only, with maximum 60° tilt. LEMO FFA.00.250 connector.

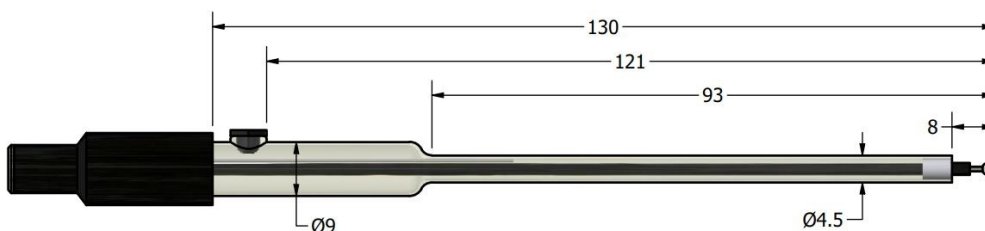

### 1.1.5 805/CPG/5G

Combined electrode, platinum ball tip and Ag/AgCl reference with frontal ceramic frit. Glass body and KCl gel reference filling solution. Developed for EC Minicell, for applications in any direction, even upside down. LEMO FFA.00.250 connector.

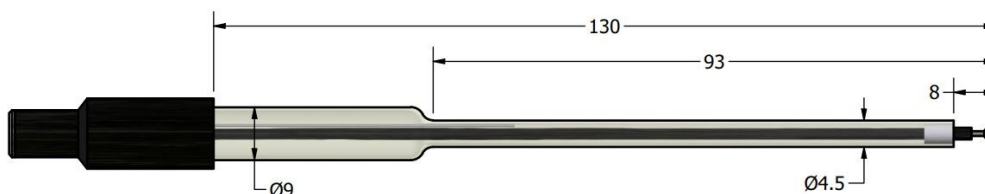

## 1.2 Silver

### 1.2.1 800/CSG/12

Standard combined electrode, 1.5mm silver ball tip and Ag/AgCl reference electrode with lateral ceramic frit. Compatible with 391/CR plastic NS12 conical tapered joint adapter.

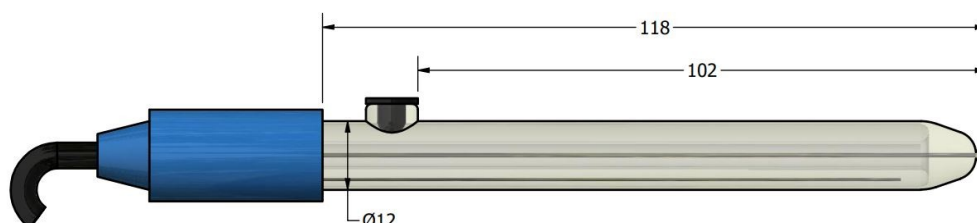

## 2 Custom Products

The available customizations are here listed. Submit our team a request if you need anything different and we will be pleased to help. Further ad hoc solutions have been developed for severe working pressures or non-conventional tube length, material and shape.

### 2.1 Conical Tapered Joint

Any electrode, either 4.5mm or 12mm body, can be equipped with plastic conical tapered joint adapter that allows for extended applications. Model 391/CR (left) has been developed for 12mm electrodes with O-Ring sealing for airtight installations, this NS12 plastic adapter can be easily removed by hand allowing for multiple uses of the same electrode. Model 391/CR6JZ (centre) is a PTFE NS6 adapter pressure fitted on 4.5mm electrodes upon request. Model 435/CR (right) allows for the use of NS6 conical tapered electrodes on NS12 fitting cells. Dimensions in mm. Adapters for specific applications can be produced.

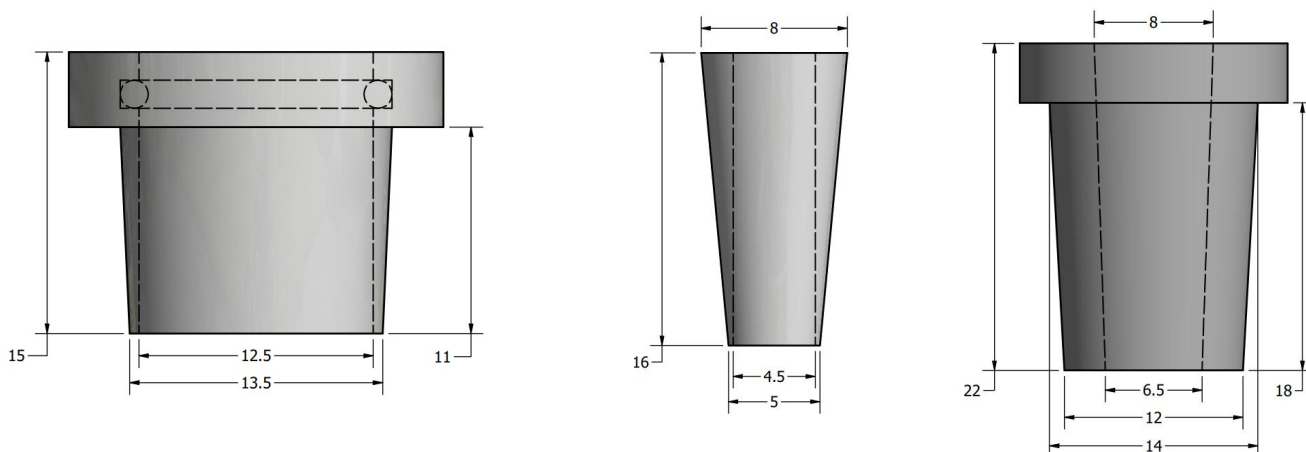

### 2.2 Connection Plug

If not otherwise specified, standard combined electrodes come with through-electrode cable. Different options are available for cable connector or connector on-the-electrode.